

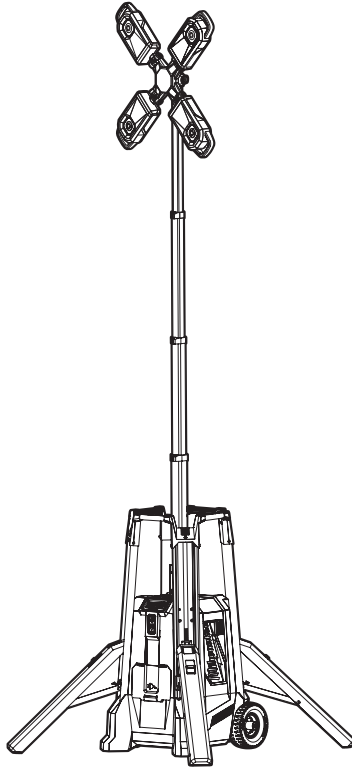

## OPERATOR'S MANUAL



Cat. No.  
**MXF TL**

### **MX FUEL™ TOWER LIGHT/CHARGER**



#### **WARNING**



To reduce the risk of injury, user must read and understand operator's manual.

# IMPORTANT SAFETY INSTRUCTIONS

**⚠WARNING** Read all safety warnings and all instructions. Failure to follow the warnings and instructions may result in electric shock, fire and/or serious injury. **Save all warnings and instructions for future reference.**

- This appliance is not intended for use by persons (including children) with reduced physical, sensory or mental capabilities, or lack of experience and knowledge, unless they have been given supervision or instruction concerning use of the appliance by a person responsible for their safety.
- Children should be supervised to ensure that they do not play with the appliance.

## WORK AREA SAFETY

- To reduce the risk of injury, close supervision is necessary when an appliance is used near children.
- Store idle light out of reach of children. Warm lights can become hazardous in the hands of children.

## ELECTRICAL SAFETY

- Power cord plugs must match the outlet. Never modify the plug in any way. Do not use any adaptor plugs with earthed (grounded) power tools. Unmodified plugs and matching outlets will reduce risk of electric shock.
- Avoid body contact with earthed or grounded surfaces, such as pipes, radiators, ranges and refrigerators. There is an increased risk of electric shock if your body is earthed or grounded.
- To reduce the risk of electric shock, do not put light in water or other liquid. Do not place or store appliance where it can fall or be pulled into a tub or sink.
- Do not abuse the cord. Never use the cord for carrying, pulling or unplugging the power tool. Keep cord away from heat, oil, sharp edges or moving parts.
- Arrange cords carefully to avoid hazardous environments. Tripping or snagging on cords can cause injury and product damage. Do not allow cords to run through puddles or across wet ground.
- Do not unplug by pulling on the cord. To unplug, grasp the plug, not the cord.
- Unplug the cord from outlet when not in use and before servicing or cleaning.
- Always use a suitable extension cord to reduce the risk of electric shock.
- If operating a light in a damp location is unavoidable, use a residual current device (RCD) protected supply. Use of a RCD reduces the risk of electric shock.
- The light source contained in this luminaire shall only be replaced by the manufacturer or his service agent or a similar qualified person.

## PERSONAL SAFETY

- Do not overreach. Keep proper footing and balance at all times. This enables better control of the light in unexpected situations.
- Do not use on a ladder or unstable support. Stable footing on a solid surface enables better control of the light in unexpected situations.

## BATTERY TOOL USE AND CARE

- Recharge only with the charger specified by the manufacturer. A charger that is suitable for one type of battery pack may create a risk of fire when used with another battery pack.

- Use light only with specifically designated battery packs. Use of any other battery packs may create a risk of injury and fire.
- Do not short circuit. A short-circuited battery pack may cause fire, personal injury, and product damage. A battery pack will short circuit if a metal object makes a connection between the positive and negative contacts on the battery pack. Do not place a battery pack near anything that may cause a short circuit, such as coins, keys or nails in your pocket.
- Do not allow fluids to flow into battery pack. Corrosive or conductive fluids, such as seawater, certain industrial chemicals, and bleach or bleach containing products, etc., can cause a short circuit.
- Under abusive conditions, liquid may be ejected from the battery; avoid contact. If contact accidentally occurs, flush with water. If liquid contacts eyes, additionally seek medical help. Liquid ejected from the battery may cause irritation or burns.
- Do not use a battery pack or tool that is damaged or modified. Damaged or modified batteries may exhibit unpredictable behaviour resulting in fire, explosion or risk of injury.
- Do not expose a battery pack or tool to fire or excessive temperature. Exposure to fire or temperature above 130°C (265°F) may cause explosion.
- Follow all charging instructions and do not charge the battery pack or tool outside the temperature range specified in the instructions. Charging improperly or at temperatures outside the specified range may damage the battery and increase the risk of fire.

## CHARGER USE AND CARE

- **⚠CAUTION** To reduce the risk of injury, charge MILWAUKEE® Lithium-Ion packs only in their MILWAUKEE® Lithium-Ion charger. Other types of batteries may burst causing personal injury and damage. Do not wire a battery pack to a power supply plug or car cigarette lighter. Batteries will be permanently disabled or damaged.
- Charge only MILWAUKEE® MX™ Lithium-Ion packs. Other types of batteries may burst causing personal injury or damage.
- Avoid dangerous environments. Do not charge battery pack in rain, snow, damp or wet locations. Do not use battery pack or charger in the presence of explosive atmospheres (gaseous fumes, dust or flammable materials) because sparks may be generated when inserting or removing battery pack, possibly causing fire.
- Charge in a well ventilated area. Do not block charger vents. Keep them clear to allow proper ventilation. Do not allow smoking or open flames near a charging battery pack. Vented gases may explode.
- Maintain charger cord. When unplugging charger, pull plug rather than cord to reduce the risk of damage to the electrical plug and cord. Never carry charger by its cord. Keep cord from heat, oil and sharp edges. Make sure cord will not be stepped on, tripped over or subjected to damage or stress. Do not use charger with damaged cord or plug. If the external flexible cable or cord is damaged, it shall be exclusively replaced by the manufacturer to avoid a hazard.
- Use only recommended attachments. Use of an attachment not recommended or sold by the battery charger or battery pack manufacturer may result in a risk of fire, electric shock or personal injury.
- Unplug charger when not in use. Remove battery packs from unplugged chargers.

- **To reduce the risk of electric shock**, always unplug charger before cleaning or maintenance. Do not allow water to flow into AC/DC plug. Use a Residual Current Device (RCD) to reduce shock hazards.
- **Store your battery and charger in a cool, dry place.** Do not store battery pack where temperatures may exceed 50°C (120°F) such as in direct sunlight, a vehicle or metal building during the summer.

## SERVICE

- **Have your light serviced by a qualified repair person using only identical replacement parts.** This will ensure that the safety of the light is maintained.
- **Never service damaged battery packs.** Service of battery packs should only be performed by the manufacturer or authorised service providers.

## SPECIFIC SAFETY RULES

**⚠️WARNING** When using flashlights or lanterns, additional precautions should always be followed, including the following:

- a) To reduce the risk of injury, close supervision is necessary when a product is used near children.
- b) Do not contact hot parts.
- c) Only use attachments recommended or sold by the manufacturer.

**⚠️WARNING** The lens may get hot during use. To reduce the risk of burns, do not touch hot lens.

**⚠️WARNING** To reduce the risk of injury, keep hands clear of the moving parts when deploying legs and/or raising/lowering the mast.

**⚠️WARNING** To reduce the risk of injury, do not look directly into the light when the light is on.

**⚠️WARNING** To reduce the risk of injury, ensure the light is stable before raising the mast. Light may tip and cause injury.

**⚠️WARNING** Do not set up the unit if high winds are expected. High winds can cause the light to tip or fall causing severe injury.

- **Light extends upward.** Verify the area above light is open and clear of overhead wires and obstructions before raising.
- **Chemical Burn Hazard.** Keep batteries away from children.
- **Always use common sense and be cautious when using tools.** It is not possible to anticipate every situation that could result in a dangerous outcome. Do not use this tool if you do not understand these operating instructions or you feel the work is beyond your capability; contact *MILWAUKEE*® Tool or a trained professional for additional information or training.
- **Maintain labels and nameplates.** These carry important information. If unreadable or missing, contact a *MILWAUKEE*® service facility for a replacement.

## ADDITIONAL BATTERY SAFETY RULES

**⚠️WARNING** To reduce the risk of fire, personal injury, and product damage due to a short circuit, never immerse your tool, battery pack or charger in fluid or allow a fluid to flow inside them. Corrosive or conductive fluids, such as seawater, certain industrial chemicals, and bleach or bleach-containing products, etc., can cause a short circuit.

**⚠️WARNING** Do not charge non-rechargeable batteries.

## Guidelines for Using Extension Cords

- If you are using an extension cord outdoors, be sure it is acceptable for outdoor use.
- Be sure your extension cord is properly wired and in good electrical condition. Always replace a damaged extension cord or have it repaired by a qualified person before using it.
- Protect your extension cords from sharp objects, excessive heat and damp or wet areas.
- When stringing lights together, consider the total Amperes draw when selecting the extension cords.

## READ AND SAVE ALL INSTRUCTIONS FOR FUTURE USE.















## GROUNDING

**⚠️DANGER** Do not use the tool if the cord or plug is damaged. If damaged, have it repaired by a *MILWAUKEE*® service facility before use.

## SPECIFICATIONS

Cat. No. ....	MXF TL
Ingress Protection (DC only).....	IP55
Battery Type .....	MX FUEL™
Charger Type.....	MX FUEL™
AC Input Volts.....	220-240V
AC Input Watts.....	960W
DC Output Volts (Charging).....	72V
DC Output Amps (Charging).....	4.5A
Recommended Ambient Charging Temperature.....	5°C to 40°C
Weight.....	47.6 kg
<b>MX FUEL™ Li-Ion Battery Packs</b> .....	72V DC

## SYMBOLOLOGY

	Volts
	Direct Current
	Alternating Current
	Amps
	Hertz
	<b>▲WARNING</b> Risk of Electric Shock
	<b>▲WARNING</b> Do not stare at the operating light source.
	Read operator's manual
	Safety Alert Symbol
	DC Power
	AC Power
	Two-person lift
	Do not dispose of electric tools together with household waste material. Electric tools and electronic equipment that have reached the end of their life must be collected separately and returned to an environmentally compatible recycling facility.
	Regulatory Compliance Mark (RCM). This product meets applicable regulatory requirements.

## FUNCTIONAL DESCRIPTION

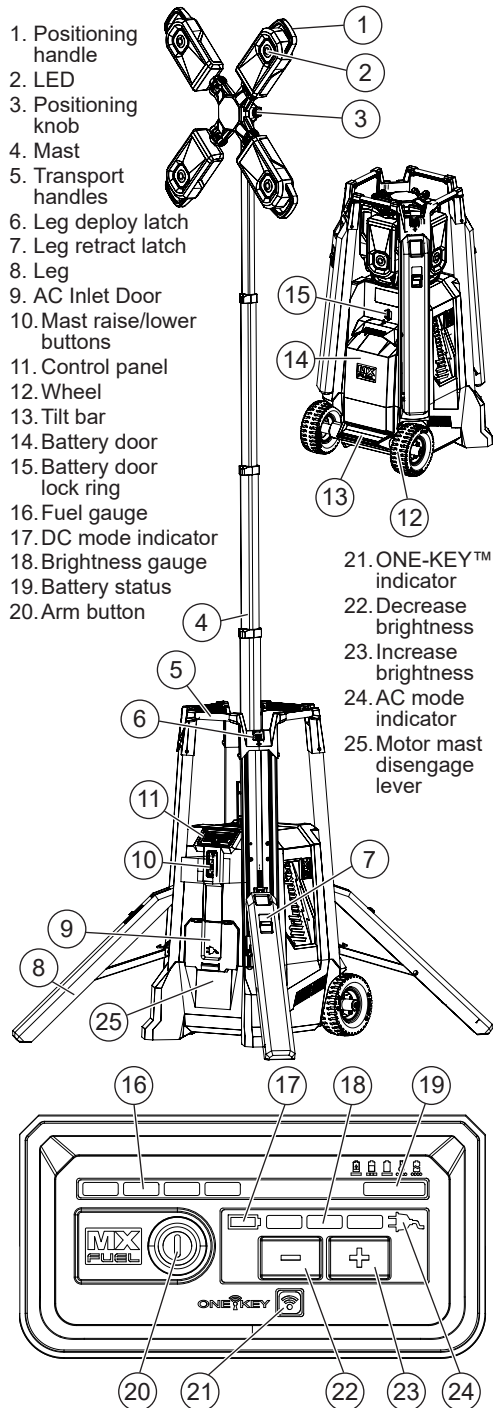

1. Positioning handle
2. LED
3. Positioning knob
4. Mast
5. Transport handles
6. Leg deploy latch
7. Leg retract latch
8. Leg
9. AC Inlet Door
10. Mast raise/lower buttons
11. Control panel
12. Wheel
13. Tilt bar
14. Battery door
15. Battery door lock ring
16. Fuel gauge
17. DC mode indicator
18. Brightness gauge
19. Battery status
20. Arm button

21. ONE-KEY™ indicator
22. Decrease brightness
23. Increase brightness
24. AC mode indicator
25. Motor mast disengage lever

## ASSEMBLY

**⚠WARNING** Recharge only with the charger specified for the battery. For specific charging instructions, read the operator's manual supplied with your charger and battery.

### Removing/Inserting the Battery

To remove the battery, push the battery latch lock to the side and squeeze the battery latch lever. Pull the battery pack away from the light.

**⚠WARNING** Always disconnect from supply and/or remove battery pack before changing or removing accessories.

To insert the battery, slide the pack into the body of the light. Make sure it latches securely into place.

**⚠WARNING** Only use accessories specifically recommended for this light. Others may be hazardous.

### Transportation

**⚠WARNING** Use two people whenever it is necessary to lift or carry the light. Light is heavy. Lift with your legs, not back. 

Always unarm the light before transporting. Disconnect extension cords before transporting. Always clear the area of obstructions before transporting.

To move light from place to place, ensure legs are folded in, grasp the transport handle and tilt the light back onto the wheels. Push, don't pull, the light.

Always use a two person lift when necessary. To lift, grasp the handle and tilt the light back onto the wheels. Have a second person grasp the lower hand pockets. Always maintain a firm footing.

Use the transport handles as anchor points when hoisting the light. Ensure the hoisting straps are rated for the weight of the light, and the straps will not slip or contact other parts during transport.

**NOTE:** Do not store the light in a hoisted position.

### Inserting/Removing Extension Cords to operate on AC Power

To operate the light on AC Power, open the  door and plug in a suitable extension cord into the light.

**NOTE:** When an extension cord is plugged into the light, the light will automatically run on AC power. Position cord in routing notch and close AC battery door during use.

To disconnect the extension cord, press the Power  button to turn off the light, then remove the cord from the outlet.

**NOTE:** When not using the AC option, make sure the AC battery door is closed completely.

### Deploying/Retracting the Legs

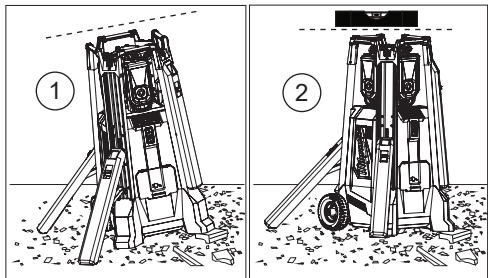

The four legs can be deployed individually. When using the light on an uneven surface, ensure the light is level and stable before use. Lower mast before making adjustments to the legs or attempting to transport the light.

1. Push the leg deploy latch to deploy a leg. Keep clear of the legs as they deploy.
2. To retract a leg, lift the leg retract latch and secure the leg back into place.

### Raising/Lowering the Mast (Motor)

Press and hold the raise/lower mast button respectively to set the light at the desired height.

**NOTE:** Before raising the mast; ensure light is stable and be aware of any potential overhead obstacles.

**NOTE:** When lowering the mast back into the unit, turn light off, lower mast to shoulder level and return heads to their outward-facing upright angle. Lowering heads while fanned-out can cause damage to unit. Lowering heads facing inward can cause damage to unit by residual heat.

**NOTE:** Keep hands away from moving parts while lowering mast.

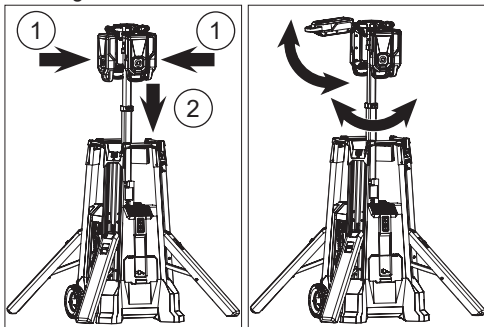
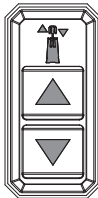

### Lowering the Mast (Power Loss)

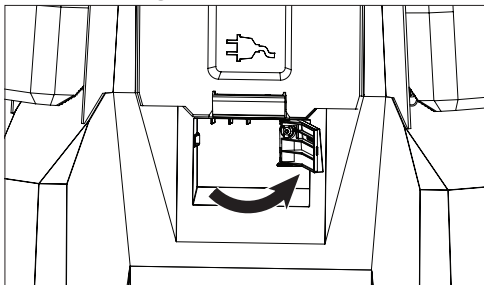

To manually lower the mast after power loss, disengage the mast motor disengage lever using the latch found below the AC Outlet access door. Reset latch once power is restored.

### Adjusting LED Heads

1. Ensure light is in upright stable position.
2. Press the Arm button.
3. Raise mast to shoulder level.
4. Rotate the heads to the desired angle. The four heads can be adjusted individually.
5. If desired, loosen the positioning knob to tilt the lights to the desired angle. Tighten knob.
6. Continue to raise the mast to the desired height.

## ONE-KEY™





To learn more about the ONE-KEY™ functionality for this tool, please refer to the quick reference included with this product or go to [onekey.milwaukeekeetools.com.au](http://onekey.milwaukeekeetools.com.au). To download the ONE-KEY™ app, visit the App Store or Google Play from your smart device.

ONE-KEY™ Indicator	
Solid Blue	Wireless mode is active and ready to be configured via the ONE-KEY™ app.
Blinking Blue	Tool is actively communicating with the ONE-KEY™ app.
Blinking Red	Tool is in security lockout and can be unlocked by the owner via the ONE-KEY™ app.

## LIGHT OPERATION

**WARNING** To reduce the risk of injury, do not look directly into the light when the light is on.

### Using the Light

1. Insert battery pack(s) or plug into AC power.
  2. Press the Arm  button.
- NOTE:** When the light is running on battery, the Battery Power Indicator  will light. When the light is running on AC power, the AC Power Indicator  will light.
3. Press the - and + buttons to cycle through **High, Medium, and Low**.
  4. Press the Arm  button to turn the light off. Always turn off power before unplugging the light.

## BATTERY OPERATION

### Fuel Gauge

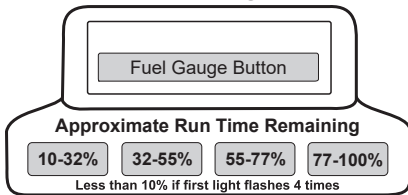

Use the Fuel Gauge to determine the battery pack's remaining run time. Press the Fuel Gauge button to display the lights. The Fuel Gauge will light up for 2-3 seconds. When less than 10% of charge is left, 1 light on the fuel gauge will flash 4 times. When the battery reaches 0% charge, 1 light on the fuel gauge will flash 8 times. Charge the battery pack.

An alternating blinking pattern indicates that an error or overtemperature state was encountered. Allow the battery pack to cool and reinsert. If the pattern continues, contact a MILWAUKEE® service facility. If the Fuel Gauge doesn't appear to be working, place the battery pack on the charger and charge as needed.

Immediately after using the battery pack, the Fuel Gauge may display a lower charge than it will if checked a few minutes later. The battery cells "re-cover" some of their charge after resting.

Under extreme circumstances, the internal temperature of the battery could become too high. If this happens, the fuel gauge lights will flash in an alternating pattern and the product will not run. Allow the battery to cool down.

Fuel Gauge Lights	Diagnosis	Solution
Lights 1 - 4 Solid	Remaining run time	Continue working
1 Light, flashing slowly	Less than 10% run time left	Prepare to charge pack
1 Light, flashing quickly	End of discharge	Charge pack
Lights 1-4, flashing quickly	Current draw too high	Release trigger. Once fuel gauge has stopped flashing, restart and reduce pressure
Lights 1&3 / 2&4, flashing alternatingly	Battery temperature too high	Release trigger and allow battery to cool
Lights 1&4 / 2&3, flashing alternatingly	Communication error	Remove the battery. Press the Fuel Gauge button to clear. Reinsert the battery. †

† If the problem persists, take the product, charger, and battery pack to a MILWAUKEE® service facility.

## CHARGER OPERATION

**WARNING** Charge only MILWAUKEE® MX FUEL™ Li-Ion batteries in this MILWAUKEE® Li-Ion charger. Other types of batteries may cause personal injury and damage.

### When to Charge the Battery Pack with this MILWAUKEE® Charger

Remove the battery pack from the product for charging when convenient for you and your job. MILWAUKEE® batteries do not develop a "memory" when charged after only a partial discharge. It is not necessary to run down the battery pack before placing it on the charger.

- Use the Fuel Gauge to determine when to charge your MILWAUKEE® Li-Ion battery pack.
- You can "Top-Off" your battery pack's charge before starting a big job or long day of use.
- The only time it is necessary to charge the MILWAUKEE® Li-Ion battery pack is when the battery pack has reached the end of its charge. To signal the end of charge, power to the product will drop quickly, allowing you just enough power to finish the operation. Charge the battery pack as needed.

### How to Charge the Battery Pack

Align the battery pack with the bay and slide the battery pack into the charger as far as possible. The red light will come on, either flashing quickly (battery pack or charger is too hot or cold), flashing slowly (communication between pack and charger) or continuous (pack is charging).

- A fully discharged battery pack with an internal temperature in the normal range will charge in about 45 to 90 minutes, depending on the battery pack and internal temperature of the charger.
- Heavily cycled batteries may take longer to charge completely.
- The fuel gauge lights are displayed as the pack is being charged, indicating how fully charged the pack is. The fuel gauge will turn off when charging is complete.
- After charging is complete, the continuous green light will come on.
- The charger will keep the battery pack fully charged if it is left on the charger. The light indicator will be same as normal charging.
- If the light indicator flashes red and green, check that the battery pack is fully seated into the bay. Remove the battery pack and reinsert. If the light continues to flash red and green, remove pack(s) and unplug charger for at least 2 minutes. After 2 minutes, plug charger back in and insert pack. If the problem persists, contact a MILWAUKEE® service facility.

• If the light indicator does not come on, check that the battery pack is fully seated into the bay. Remove the battery pack and reinsert. If the light indicator still does not come on, remove pack(s) and unplug charger for at least 2 minutes. After 2 minutes, plug charger back in and insert pack. If after these attempts the light indicator still does not come on, contact a **MILWAUKEE**® service facility.

### Charging a Hot or Cold Battery Pack

The fast Red Flashing Indicator light on the charger indicates that the battery pack or charger temperature is outside the charging range. Once the battery pack or charger is within the acceptable range, normal charging will take place and the red light will be continuous. Hot or cold batteries may take longer to charge.

Li-Ion Charging Status		
Battery Pack or Charger Temperature	Red Charger Indicator Light	Charging Status
Too Hot	Fast Flashing	Not charging
Normal Range	Continuous	Normal charging
Too Cold	Fast Flashing	Not charging

### MAINTENANCE

**⚠WARNING** To reduce the risk of injury, always unplug the tool and charger and remove the battery pack from the charger or tool before performing any maintenance. Never disassemble the tool, battery pack or charger. Contact a **MILWAUKEE**® service facility for ALL repairs.

To reduce the risk of fire, personal injury, and product damage due to a short circuit, never immerse your tool, battery pack or charger in fluid or allow a fluid to flow inside them. Corrosive or conductive fluids, such as seawater, certain industrial chemicals, and bleach or bleach containing products, etc., can cause a short circuit.

### Maintain Light

Keep your light, battery pack and charger in good repair by adopting a regular maintenance program. If the light does not work properly, return the light to a **MILWAUKEE**® service facility for repairs.

### ONE-KEY™

**⚠WARNING** Chemical Burn Hazard. This device contains a lithium button/coin cell battery. A new or used battery can cause severe internal burns and lead to death in as little as 2 hours if swallowed or enters the body. Always secure the battery cover. If it does not close securely, stop using the device, remove the batteries, and keep it away from children. If you think batteries may have been swallowed or entered the body, seek immediate medical attention.



### Internal Battery

An internal battery is used to facilitate full ONE-KEY™ functionality.

If the Mode Indicator LED turns off and the machine cannot adjust speed, or if the Bluetooth communication stops working, remove and reinsert the coin cell battery to reset. Replace the battery if the problem continues.

To replace the battery:

1. Remove the battery pack.
2. Remove the screw(s) and open the battery door.

3. Remove the old battery, keep it away from children, and dispose of it properly.
4. Insert the new battery (3V CR2032), with the positive side facing up.
5. Close the battery door and tighten the screw(s) securely.

**⚠WARNING** To reduce the risk of personal injury, electric shock and damage, never immerse your machine in liquid or allow a liquid to flow inside it.

### Cleaning

Clean dust and debris from vents. Keep handles clean, dry and free of oil or grease. Use only mild soap and a damp cloth to clean, since certain cleaning agents and solvents are harmful to plastics and other insulated parts. Some of these include gasoline, turpentine, lacquer thinner, paint thinner, chlorinated cleaning solvents, ammonia and household detergents containing ammonia. Never use flammable or combustible solvents around machines.

### Cleaning the Battery and Battery Bay

Keep battery connections and surfaces between the machine and battery free of debris and materials. Failure to keep surfaces clean may result in misalignment and/or damage to the battery connection.

### Repairs

For repairs, return the machine to the nearest authorised service centre.

### ACCESSORIES

**⚠WARNING** Use only recommended accessories. Others may be hazardous.

For a complete listing of accessories, go online to [www.milwaukeeetool.com.au/](http://www.milwaukeeetool.com.au/) [www.milwaukeeetool.co.nz](http://www.milwaukeeetool.co.nz) or contact a distributor.

## **WARRANTY - AUSTRALIA and NEW ZEALAND**

Please refer to Australian and New Zealand warranty supplied with tool. This warranty applies only to product sold by authorised dealers in Australia and New Zealand.

## **SERVICE - AUSTRALIA and NEW ZEALAND**

**MILWAUKEE®** prides itself in producing a premium quality product that is Nothing But Heavy Duty™. Your satisfaction with our products is very important to us! If you encounter any problems with the operation of this tool, please contact your authorised **MILWAUKEE®** dealer.

For a list of **MILWAUKEE®** dealers, guarantee or service agents please contact **MILWAUKEE®** Customer Service or visit our website.

(Australia Toll Free Telephone Number 1300 645 928)

(New Zealand Toll Free Telephone Number 0800 645 928)

or visit [milwaukeetool.com.au/milwaukeetool.co.nz](http://milwaukeetool.com.au/milwaukeetool.co.nz).

### **Milwaukee Electric Tool Corporation**

13135 West Lisbon Road, Brookfield, Wisconsin U.S.A. 53005

### **Milwaukee Tool (Australia)**

21 Kelletts Road, Rowville, VIC 3178  
Melbourne, Australia

### **Milwaukee Tool (New Zealand)**

274 Church Street, Penrose,  
Auckland, 1061, New Zealand

DESIGNED BY MILWAUKEE ELECTRIC TOOL CORP.

PROFESSIONALLY MADE IN U.S.A.

PRINTED IN U.S.A.