

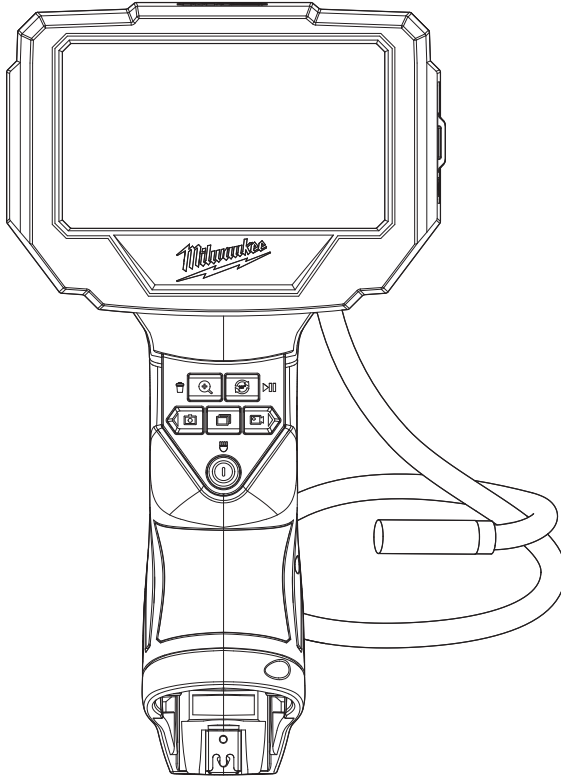

OPERATOR'S MANUAL



Cat. No.
M12 360IC32

M12™ M-SPECTOR™ 360 INSPECTION CAMERA



WARNING

To reduce the risk of injury, user must read and understand operator's manual.

GENERAL POWER TOOL SAFETY WARNINGS

AWARNING Read all safety warnings and all instructions, illustrations and specifications provided with this power tool. Failure to follow all instructions listed below may result in electric shock, fire and/or serious injury. **Save all warnings and instructions for future reference.** The term "power tool" in the warnings refers to your mains-operated (corded) power tool or battery-operated (cordless) power tool.

WORK AREA SAFETY

- **Keep work area clean and well lit.** Cluttered or dark areas invite accidents.
- **Do not operate power tools in explosive atmospheres, such as in the presence of flammable liquids, gases or dust.** Power tools create sparks which may ignite the dust or fumes.
- **Do not operate power tool in an area where it could contact electrical wiring or an electrically charged object.** Contact with a "live" wire or object will make exposed metal parts of the tool "live" and shock the operator.
- **Do not operate power tool near moving machinery.** The cable can be tangled in moving parts, pulling in the power tool and your hands and arms.
- **Do not use near any heat sources** such as radiators, heat registers, stoves, or other apparatus (including amplifiers) that produce heat.
- **Keep children and bystanders away while operating a power tool.** Distractions can cause you to lose control.

ELECTRICAL SAFETY

- **Do not expose power tools to rain or wet conditions.** Water entering a power tool will increase the risk of electric shock. Dry hands before turning tool on or off and before removing or installing the battery pack.

PERSONAL SAFETY

- **Stay alert, watch what you are doing and use common sense when operating a power tool. Do not use a power tool while you are tired or under the influence of drugs, alcohol or medication.** A moment of inattention while operating power tools may result in serious personal injury.
- **Use personal protective equipment. Always wear eye protection.** Protective equipment such as dust mask, non-skid safety shoes, hard hat, or hearing protection used for appropriate conditions will reduce personal injuries.
- **Do not overreach. Keep proper footing and balance at all times.** This enables better control of the power tool in unexpected situations.

POWER TOOL USE AND CARE

- **This Inspection Scope is not intended for medical use or personal inspection.**
- **Store idle power tools out of the reach of children and do not allow persons unfamiliar with the power tool or these instructions to operate the power tool.** Power tools are dangerous in the hands of untrained users.
- **Maintain power tools. Check for misalignment or binding of moving parts, breakage of parts and any other condition that may affect the power tool operation. Do not use if power tool smokes or gives off fumes. If damaged, have the power tool repaired before use.** Many accidents are caused by poorly maintained power tools.

- **Use the power tool, accessories and tool bits etc., in accordance with these instructions, taking into account the working conditions and the work to be performed.** Use of the power tool for operations different from those intended could result in a hazardous situation. Only use accessories specifically recommended for this tool. Others may be hazardous.
- **Clean only with dry cloth.** Certain cleaning agents and solvents are harmful to plastics and other insulated parts. Some of these include: petrol, turpentine, lacquer thinner, paint thinner, chlorinated cleaning solvents, ammonia and household detergents containing ammonia. Clean dust and debris from vents. Keep the apparatus handle clean, dry and free of oil or grease.

BATTERY USE AND CARE

- **Always remove the battery pack before cleaning.**
- **This tool is designed to be powered by a 12 volt MILWAUKEE® battery pack.** Do not attempt to use with any other voltage or power supply.
- **Recharge only with the charger specified by the manufacturer.** A charger that is suitable for one type of battery pack may create a risk of fire when used with another battery pack.
- **Use power tools only with specifically designated battery packs.** Use of any other battery packs may create a risk of injury and fire.
- **When battery pack is not in use, keep it away from other metal objects like paper clips, coins, keys, nails, screws, or other small metal objects that can make a connection from one terminal to another.** Shorting the battery terminals together may cause burns or a fire.
- **Under abusive conditions, liquid may be ejected from the battery, avoid contact. If contact accidentally occurs, flush with water. If liquid contacts eyes, additionally seek medical help.** Liquid ejected from the battery may cause irritation or burns.

SERVICE

- **Contact a MILWAUKEE® service facility for ALL repairs. Have your power tool serviced by a qualified repair person using only identical replacement parts.** This will ensure that the safety of the power tool is maintained.
- **Never disassemble the power tool or try to do any rewiring on the power tool's electrical system.**

SPECIFIC SAFETY RULES FOR INSPECTION CAMERA

- **Do not store the tool in an area of high heat or humidity. Do not expose the tool to extended high heat from the sun (such as on a vehicle dashboard.)** Damage to the product or the battery pack can result.
- **Maintain labels and nameplates. These carry important information.** If unreadable or missing, contact a MILWAUKEE® service facility for a replacement.

ADDITIONAL BATTERY SAFETY RULES

⚠WARNING To reduce the risk of fire, personal injury, and product damage due to a short circuit, never immerse your tool, battery pack or charger in fluid or allow a fluid to flow inside them. Corrosive or conductive fluids, such as seawater, certain industrial chemicals, and bleach or bleach-containing products, etc., can cause a short circuit.

⚠WARNING Do not charge non-rechargeable batteries.

⚠WARNING Do not dispose of a battery into fire or a hot oven, or mechanically crushing or cutting of a battery, that can result in an explosion.

⚠WARNING Do not leaving a battery in an extremely high temperature surrounding environment that can result in an explosion or the leakage of flammable liquid or gas.

⚠WARNING Do not expose the battery to extremely low air pressure that may result in an explosion or the leakage of flammable liquid or gas.

FUNCTIONAL DESCRIPTION

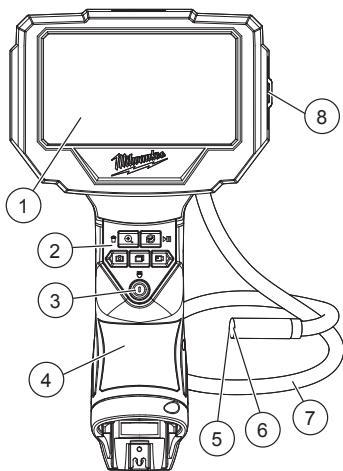

1. LCD
2. Zoom/Rotate Capture/Playback buttons
3. Power button/camera LED brightness selector
4. Handle
5. Camera LEDs
6. Camera
7. Cable
8. Memory card slot

SPECIFICATIONS

| | |
|-----------------------------|-----------------------------------|
| Cat. No..... | M12 360IC32 |
| Volts..... | 12V DC |
| Battery Type..... | M12™ |
| Charger Type..... | M12™ |
| Cable Length..... | 3 m (2324-20) |
| Memory Card..... | Micro-SD (32GB supplied) |
| Display Size..... | 110 mm (4.3") |
| Camera Resolution..... | 720 p |
| Camera Head Diameter..... | 11 mm |
| Digital Image Rotation..... | 180° |
| Drop Rating..... | 1 m |
| Storage Temperature..... | -17°C to 60°C (-4°F to 140°F) |
| Operating Temperature..... | -10°C to 40°C (-14°F to 104°F) |

SYMBOLGY



Volts



Direct Current



To prevent electric shock, do not allow product to contact live electrical parts



Do not stare at the operating light source



Wear eye protection



Read Operator's Manual



Indoor use



Regulatory Compliance Mark (RCM). This product meets applicable regulatory requirements.



Do not dispose of electric tools together with household waste material. Electric tools and electronic equipment that have reached the end of their life must be collected separately and returned to an environmentally compatible recycling facility.

ASSEMBLY

⚠WARNING Recharge only with the charger specified for the battery. For specific charging instructions, read the operator's manual supplied with your charger and battery.

Inserting/Removing the Battery

To **insert** the battery, slide the pack into the body of the tool. Make sure it latches securely into place.

⚠WARNING Only use accessories specifically recommended for this tool. Others may be hazardous.

To **remove** the battery, push in the release buttons and pull the battery pack away from the tool.

⚠WARNING Always remove the battery pack any time the tool is not in use.

Inserting/Removing the Memory Card

The number of photos/videos that can be saved is based on the size of the memory card.

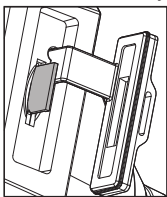

1. Open the protective cover to access the memory card slot.
2. Slide the memory card into the slot, the top of the card should face away from the LCD screen. Press in the card securely. It should click in place.
3. Close the protective cover.
4. To **remove** the memory card, press it in and release. It will pop out.



NOTE: To transfer photos/video to an external device, the Micro-SD card must be removed and inserted into external device. The Micro-SD card can also be used with the supplied SD Card adaptor to transfer photos/videos to external devices. To delete or save to the Micro SD Card when installed in the adaptor, ensure the 'lock' switch on the side of the adaptor is not in the 'lock' position (lower position).

Formatting a New Memory Card

The camera comes preinstalled with a memory card formatted to FAT32. The  indicator will display if a memory card is inserted that is not formatted to FAT32. Memory cards must be formatted to FAT32. **NOTE:** Formatting will erase all existing data including any photos and videos contained on that memory card.

To **format** a memory card to FAT32, press the  button twice. The  indicator will display until formatting is completed and the tool will turn off.

Attaching/Removing Accessories

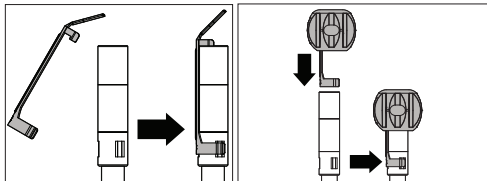

To **attach** an accessory, snap the clips into the dents at the end of the cable. To **remove**, unclip and pull away from the cable.

OPERATION

⚠WARNING To reduce the risk of injury, always wear proper eye protection marked to comply with AS/NZS 1337.

To reduce the risk of explosion, electric shock and property damage, always check the work area before beginning a job. Do not allow cable to contact electrical, chemical, or moving hazards. Behind walls: Shut off circuit breakers to the entire area.

Inside pipes: Ensure there is no electrical charge to the pipes before beginning inspection. Do not allow liquid to flow down cable and into tool.

Vehicle use: Turn off the engine and allow to cool before beginning inspection. Do not allow the camera or cable to contact oil, gas, or other corrosive materials.

NOTICE To reduce the risk of damage to the tool, do not use excessive force or "kink" the cable. Do not use in areas where camera and cable will contact corrosive or oily substances. Do not use the cable to clear clogs or move obstructions. This is not a drain cleaner!

① Turning On/Off

When the inspection camera is turned On and the camera is pointed at an object, the LCD screen will show the image the lens is pointing at.



To turn On:

1. Press and hold the power button .
2. Release the power button  when the screen turns On.

To turn Off:

1. Press and hold the power button .
2. Release the power button  when the screen turns Off.



Camera LED Brightness

Once the tool is turned On, press the power button  to cycle through the levels of brightness or turn it Off. The level of brightness  is displayed on the LCD.

Zoom Button

Press the zoom button  to cycle through the 3 zoom levels. The level of zoom is displayed on the LCD.



Rotate Button

Press the  button to rotate the LCD image 180°. Push the  button again to return the image to its original position.

Save Photo Button

Press the  button to save a photo of the current view of the LCD screen.

Record Video Button

Press the  button to start recording the current view of the LCD screen. Press the  button again to stop recording.

Taking Photos/Videos

1. Adjust the cable to best fit the opening. After checking the workspace for hazards, insert the cable.
 2. Use the  button to zoom in or out on the image.
 3. Use the  button to rotate the image 180°.
 4. Use the power button  to increase/decrease the camera LED brightness.
 5. To save a photo, press the  button.
 6. To record a video, press the  button.
- NOTE:** During a video recording, REC displays on the LCD and the timecode starts counting up.
7. To end the video, press .

Gallery Mode

NOTE: When in gallery mode, button actions change to their secondary functions to allow for navigation, playback, pause, and deletion purposes.

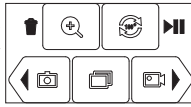

1. Press the button to enter gallery mode to view photos and videos saved on the SD card.
2. The number of saved photos/videos is displayed on the top of the LCD screen. 2/50
3. While in gallery mode, use the buttons to move through the stored photos/videos.
4. Press the button to play a saved video.
5. While a video is playing, press the button to pause.
6. To delete a photo/video, press the button then press the button again to confirm the deletion.
7. To cancel a deletion, press the button.
8. To exit gallery mode, press the button.

Battery Level

Replace the battery pack when low. The level of battery is displayed in the upper right corner of the LCD screen.

Sleep Mode

The tool will shut off automatically if unused for 5 minutes.

Memory Card Missing

The indicator will display if a memory card is not detected in the memory card slot.

No Media Detected

The indicator will display if there is no media detected on the memory card.

Memory Card Full

The indicator will display if the memory card is full.

File Archive

The indicator will display when the maximum number of photos/videos that can be displayed in Gallery Mode is reached. The files need to be moved to the archive folder of the memory card. To move files to the archive folder, press the button twice.

Over Temperature

If the battery over temperature indicator comes on, remove the battery and allow the battery to cool.

Rotating Screen

To rotate the screen for ease of use, grasp the LCD housing and turn clockwise or counter clockwise. The screen can be rotated approximately 270°.

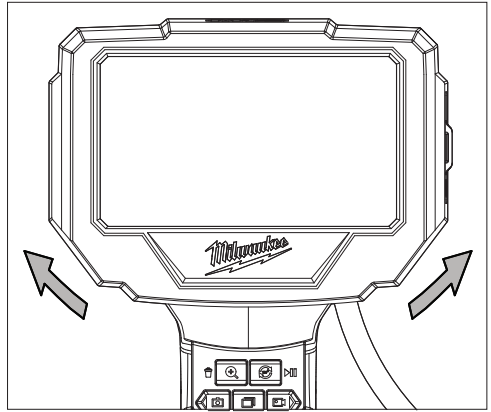

MAINTENANCE

WARNING To reduce the risk of injury, always remove the batteries from the tool before performing any maintenance. Never disassemble the tool. Contact a MILWAUKEE® service facility for ALL repairs.

Maintaining Tool

Keep your tool in good repair by adopting a regular maintenance program. After six months to one year, depending on use, return the tool to a MILWAUKEE® service facility for repairs.

If the tool does not start or operate at full power with new batteries, clean the contacts on the battery door. If the tool still does not work properly, return the tool to a MILWAUKEE® service facility for repairs.

WARNING To reduce the risk of personal injury and damage, never immerse your tool in liquid or allow a liquid to flow inside it.

Cleaning

Clean dust and debris from any vents. Keep tool clean, dry and free of oil or grease. Use only mild soap and a damp cloth to clean, since certain cleaning agents and solvents are harmful to plastics and other insulated parts. Some of these include petrol, turpentine, lacquer thinner, paint thinner, chlorinated cleaning solvents, ammonia and household detergents containing ammonia. Never use flammable or combustible solvents around tools.

Repairs

For repairs, return the tool, battery pack and charger to the nearest authorised service centre.

ACCESSORIES

WARNING Use only recommended accessories. Others may be hazardous.

For a complete listing of accessories, go online to milwaukeeetool.com.au/milwaukeeetool.co.nz or contact a distributor.

WARRANTY - AUSTRALIA and NEW ZEALAND

Please refer to Australian and New Zealand warranty supplied with tool. This warranty applies only to product sold by authorised dealers in Australia and New Zealand.

SERVICE - AUSTRALIA and NEW ZEALAND

MILWAUKEE® prides itself in producing a premium quality product that is Nothing But Heavy Duty™. Your satisfaction with our products is very important to us! If you encounter any problems with the operation of this tool, please contact your authorised **MILWAUKEE®** dealer.

For a list of **MILWAUKEE®** dealers, guarantee or service agents please contact **MILWAUKEE®** Customer Service or visit our website.

(Australia Toll Free Telephone Number 1300 645 928)

(New Zealand Toll Free Telephone Number 0800 645 928)

or visit milwaukeetool.com.au/milwaukeetool.co.nz.

Milwaukee Electric Tool Corporation

13135 West Lisbon Road, Brookfield, Wisconsin U.S.A. 53005

Milwaukee Tool (Australia)

26 - 40 Nina Link, Dandenong South,
Victoria, 3175, Australia

Milwaukee Tool (New Zealand)

274 Church Street, Penrose,
Auckland, 1061, New Zealand

DESIGNED BY MILWAUKEE ELECTRIC TOOL CORP.