

Cat. No.  
**M18 CBS125S**

## **M18 FUEL™ DEEP CUT DUAL-TRIGGER BAND SAW**

 **WARNING** To reduce the risk of injury, user must read and understand operator's manual.





## GENERAL POWER TOOL SAFETY WARNINGS

**⚠WARNING** Read all safety warnings, instructions, illustrations and specifications provided with this power tool. Failure to follow all instructions listed below may result in electric shock, fire and/or serious injury. **Save all warnings and instructions for future reference.** The term "power tool" in the warnings refers to your mains-operated (corded) power tool or battery-operated (cordless) power tool.

### WORK AREA SAFETY

- **Keep work area clean and well lit.** Cluttered or dark areas invite accidents.
- **Do not operate power tools in explosive atmospheres, such as in the presence of flammable liquids, gases or dust.** Power tools create sparks which may ignite the dust or fumes.
- **Keep children and bystanders away while operating a power tool.** Distractions can cause you to lose control.

### ELECTRICAL SAFETY

- **Power tool plugs must match the outlet. Never modify the plug in any way. Do not use any adapter plugs with earthed (grounded) power tools.** Unmodified plugs and matching outlets will reduce risk of electric shock.
- **Avoid body contact with earthed or grounded surfaces, such as pipes, radiators, ranges and refrigerators.** There is an increased risk of electric shock if your body is earthed or grounded.
- **Do not expose power tools to rain or wet conditions.** Water entering a power tool will increase the risk of electric shock.
- **Do not abuse the cord. Never use the cord for carrying, pulling or unplugging the power tool. Keep cord away from heat, oil, sharp edges or moving parts.** Damaged or entangled cords increase the risk of electric shock.
- **When operating a power tool outdoors, use an extension cord suitable for outdoor use.** Use of a cord suitable for outdoor use reduces the risk of electric shock.
- **If operating a power tool in a damp location is unavoidable, use a residual current circuit breaker (RCD) protected supply.** Use of a RCD reduces the risk of electric shock.

### PERSONAL SAFETY

- **Stay alert, watch what you are doing and use common sense when operating a power tool. Do not use a power tool while you are tired or under the influence of drugs, alcohol or medication.** A moment of inattention while operating power tools may result in serious personal injury.
- **Use personal protective equipment. Always wear eye protection.** Protective equipment such as a dust mask, non-skid safety shoes, hard hat or hearing protection used for appropriate conditions will reduce personal injuries.
- **Prevent unintentional starting. Ensure the switch is in the off-position before connecting to power source and/or battery pack, picking up or carrying the tool.** Carrying power tools with your finger on the switch or energizing power tools that have the switch on invites accidents.

- **Remove any adjusting key or wrench before turning the power tool on.** A wrench or a key left attached to a rotating part of the power tool may result in personal injury.
- **Do not overreach. Keep proper footing and balance at all times.** This enables better control of the power tool in unexpected situations.
- **Dress properly. Do not wear loose clothing or jewelry. Keep your hair and clothing away from moving parts.** Loose clothes, jewelry or long hair can be caught in moving parts.
- **If devices are provided for the connection of dust extraction and collection facilities, ensure these are connected and properly used.** Use of dust collection can reduce dust-related hazards.
- **Do not let familiarity gained from frequent use of tools allow you to become complacent and ignore tool safety principles.** A careless action can cause severe injury within a fraction of a second.

### POWER TOOL USE AND CARE

- **Do not force the power tool. Use the correct power tool for your application.** The correct power tool will do the job better and safer at the rate for which it was designed.
  - **Do not use the power tool if the switch does not turn it on and off.** Any power tool that cannot be controlled with the switch is dangerous and must be repaired.
  - **Disconnect the plug from the power source and/ or remove the battery pack, if detachable, from the power tool before making any adjustments, changing accessories, or storing power tools.** Such preventive safety measures reduce the risk of starting the power tool accidentally.
  - **Store idle power tools out of the reach of children and do not allow persons unfamiliar with the power tool or these instructions to operate the power tool.** Power tools are dangerous in the hands of untrained users.
  - **Maintain power tools and accessories. Check for misalignment or binding of moving parts, breakage of parts and any other condition that may affect the power tool's operation. If damaged, have the power tool repaired before use.** Many accidents are caused by poorly maintained power tools.
  - **Keep cutting tools sharp and clean.** Properly maintained cutting tools with sharp cutting edges are less likely to bind and are easier to control.
  - **Use the power tool, accessories and tool bits etc. in accordance with these instructions, taking into account the working conditions and the work to be performed.** Use of the power tool for operations different from those intended could result in a hazardous situation.
  - **Keep handles and grasping surfaces dry, clean and free from oil and grease.** Slippery handles and grasping surfaces do not allow for safe handling and control of the tool in unexpected situations.
- ### BATTERY TOOL USE AND CARE
- **Recharge only with the charger specified by the manufacturer.** A charger that is suitable for one type of battery pack may create a risk of fire when used with another battery pack.
  - **Use power tools only with specifically designated battery packs.** Use of any other battery packs may create a risk of injury and fire.

•When battery pack is not in use, keep it away from other metal objects, like paper clips, coins, keys, nails, screws or other small metal objects, that can make a connection from one terminal to another. Shorting the battery terminals together may cause burns or a fire.

•Under abusive conditions, liquid may be ejected from the battery; avoid contact. If contact accidentally occurs, flush with water. If liquid contacts eyes, additionally seek medical help. Liquid ejected from the battery may cause irritation or burns.

•Do not use a battery pack or tool that is damaged or modified. Damaged or modified batteries may exhibit unpredictable behavior resulting in fire, explosion or risk of injury.

•Do not expose a battery pack or tool to fire or excessive temperature. Exposure to fire or temperature above 130°C (265°F) may cause explosion.

•Follow all charging instructions and do not charge the battery pack or tool outside the temperature range specified in the instructions. Charging improperly or at temperatures outside the specified range may damage the battery and increase the risk of fire.

### SERVICE

•Have your power tool serviced by a qualified repair person using only identical replacement parts. This will ensure that the safety of the power tool is maintained.

•Never service damaged battery packs. Service of battery packs should only be performed by the manufacturer or authorized service providers.

### SPECIFIC SAFETY RULES FOR BAND SAWS

•Hold power tool by insulated gripping surfaces, when performing an operation where the cutting accessory may contact hidden wiring. Cutting accessories contacting a "live" wire may make exposed metal parts of the power tool "live" and could give the operator an electric shock.

•**⚠ DANGER** Keep hands away from cutting area and the blade. Keep your second hand on handle. If both hands are holding the saw, they cannot be cut by the blade.

•**⚠ WARNING** To reduce the risk of injury, when working in dusty situations, wear appropriate respiratory protection or use an OSHA compliant dust extraction solution.

•Always use common sense and be cautious when using tools. It is not possible to anticipate every situation that could result in a dangerous outcome. Do not use this tool if you do not understand these operating instructions or you feel the work is beyond your capability; contact Milwaukee Tool or a trained professional for additional information or training.

•Maintain labels and nameplates. These carry important information. If unreadable or missing, contact a MILWAUKEE® service facility for a free replacement.

•**⚠ WARNING** Some dust created by power sanding, sawing, grinding, drilling, and other construction activities contains chemicals known to cause cancer, birth defects or other reproductive harm. Some examples of these chemicals are:

- lead from lead-based paint
- crystalline silica from bricks and cement and other masonry products, and

•arsenic and chromium from chemically-treated lumber.

Your risk from these exposures varies, depending on how often you do this type of work. To reduce your exposure to these chemicals: work in a well ventilated area, and work with approved safety equipment, such as those dust masks that are specially designed to filter out microscopic particles.

### SYMBOLGY

V Volts

--- Direct Current

**SMPM** No Load Surface Metres per Minute (SMPM)

Ⓜ Regulatory Compliance Mark (RCM). This product meets applicable regulatory requirements.

📖 Read Operator's Manual

### ADDITIONAL BATTERY SAFETY RULES

**⚠ WARNING** To reduce the risk of fire, personal injury, and product damage due to a short circuit, never immerse your tool, battery pack or charger in fluid or allow a fluid to flow inside them. Corrosive or conductive fluids, such as seawater, certain industrial chemicals, and bleach or bleach-containing products, etc., can cause a short circuit.

### SPECIFICATIONS

Cat. No. ....	<b>M18 CBS125S</b>
Volts.....	18V DC
Battery Type.....	M18™
Charger Type.....	M18™
SMPM.....	0-116
Recommended Blades.....	1140mm x 12.7 Bi-Metal

### Capacities

Round Stock.....	125mm
Rectangular Stock.....	125mm x 125mm
Recommended Ambient Operating Temperature.....	-17°C to 50°C

### FUNCTIONAL DESCRIPTION

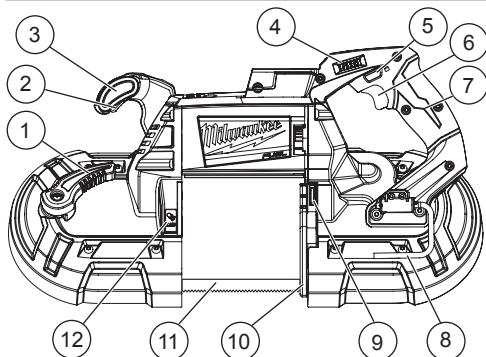

- |                         |                            |
|-------------------------|----------------------------|
| 1. Tension lock         | 7. Handle                  |
| 2. Front handle trigger | 8. Hang hook               |
| 3. Front handle         | 9. Guide adjustment button |
| 4. Speed dial           | 10. Material guide         |
| 5. Trigger lock         | 11. Blade                  |
| 6. Rear handle trigger  | 12. LED ON button          |

## ASSEMBLY

**⚠WARNING** Recharge only with the charger specified for the battery. For specific charging instructions, read the operator's manual supplied with your charger and battery.

### Removing/Inserting the Battery

To remove the battery, push in the release buttons and pull the battery pack away from the tool.

**⚠WARNING** Always remove battery pack before changing or removing accessories.

To insert the battery, slide the pack into the body of the tool. Make sure it latches securely into place.

**⚠WARNING** Only use accessories specifically recommended for this tool. Others may be hazardous.

### Blades and Blade Selection

The blade dimensions required for this band saw are: .5mm thickness, 12.7mm width and 1139.8mm in length. special 0.5mm thickness reduces flexure fatigue and provides maximum tooth life. To maximise cutting life, use a blade with the correct pitch (teeth per inch) for the specific cutting job.

Blades are available in several pitches. To select the proper blade, three factors should be considered: The size, shape, and type of material to be cut.

The following suggestions are for selecting the right blade for various cutting operations. Keep in mind that these are broad guidelines and that blade requirements may vary depending upon the specific size, shape and type of material to be cut. Generally, soft materials require coarse pitch blades and hard materials require fine pitch blades. Use coarse pitch blades for thick work and fine pitch blades for thin work. It is important to keep at least three teeth in the cut (see "Typical Application").

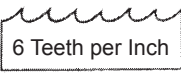
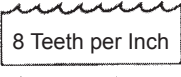
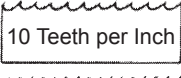
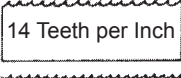
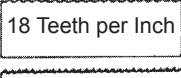
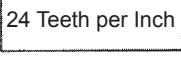
 6 Teeth per Inch	• For tough stock 13mm to 86mm in diameter or width (available in carbon steel only).
 8 Teeth per Inch	• For tough stock 10mm to 25.4mm in diameter or width (available in carbon steel only).
 10 Teeth per Inch	• For tough stock 5mm up to 120mm in diameter or width.
 14 Teeth per Inch	• For tough stock 4mm to 19mm in diameter or width.
 18 Teeth per Inch	• For thin-wall tubing and thin sheets heavier than 21 gauge.
 24 Teeth per Inch	• For thin-wall tubing and thin sheets heavier than 21 gauge.

**⚠WARNING** Do not touch blade immediately after use. Blade will be hot.

### Changing Blades

1. REMOVE BATTERY PACK BEFORE CHANGING OR REMOVING BLADES.
2. Turn the tension lock handle located on the front of the saw 180° counterclockwise. This releases the tension on the blade for easy removal.
3. Remove the blades from the pulley first and then from the guides.
4. To install a new blade, with the pulleys facing up, insert the blade between the rollers and the faces of the guides, making sure that the teeth on the left side of the tool point towards the rear of the tool.
5. With one hand, hold the blade in place between the rollers and the guides and use the other hand to position the blade around the pulleys. Be sure that the blade lies freely within the guard channel before starting the tool motor.
6. Turn the tension lock handle 180° clockwise to lock the position. This will secure the blade on the pulleys. **BE SURE THAT THE BLADE IS PROPERLY SEATED ON THE PULLEYS BEFORE STARTING THE CUT.**

### Adjusting the 3-Position Material Guide

1. Remove the battery pack.
2. Press in the guide adjustment button and slide the material guide to the desired position detent.

### LED Worklight

The LED worklight is turned on automatically when the trigger is pulled. To turn on the LED to line-up a cut or light-up the workpiece, press the LED On Button. The LED will go off automatically after about 30 seconds.

## OPERATION

**⚠WARNING** To reduce the risk of injury, always remove battery pack before changing or removing accessories. Only use accessories specifically recommended for this tool. Others may be hazardous.

Always wear proper eye protection.

When working in dusty situations, wear appropriate respiratory protection or use a dust extraction solution.

### Trigger Lock

To lock the trigger, push the trigger lock to the right. The trigger will not work while the switch is in the locked position. Always lock the trigger and remove the battery pack before performing maintenance and when changing accessories. Lock the trigger when storing the tool and when the tool is not in use.

### Speed Dial

These Band Saws have a speed dial located on the side of the handle to set the maximum speed. Rotate the speed dial to "5" for maximum speed, "1" for minimum speed.

### Starting and Stopping

This band saw requires both triggers to be pulled at all times during use. If either trigger is released, the tool will stop. Release both triggers and restart the tool.

1. To **start** the tool, grasp both handles firmly.

2. Pull and hold the rear handle trigger, then, pull the front handle trigger.  
**NOTE:** The LED is turned on when the rear handle trigger is pulled.

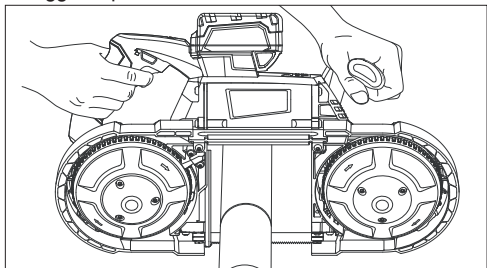

3. To **vary** the speed, increase or decrease pressure on the rear handle trigger. The further the trigger is pulled, the greater the speed.
4. To **stop** the tool, release both triggers. Allow the tool to come to a complete stop before removing the blade from a partial cut or laying down the tool.

### Typical Application

1. Keep the blade off of the workpiece until the motor has reached the selected speed.
2. Start cutting on a surface where the greatest number of teeth will be in contact with the workpiece at one time.

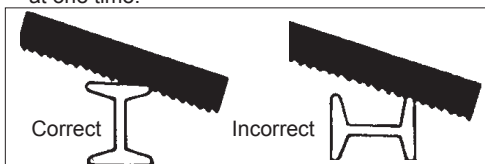

3. Place the material guide against the workpiece and lower the moving saw blade into the cut.
4. Do not bear down while cutting. The weight of the tool will supply adequate pressure for the fastest cutting.
5. When completing a cut, hold the tool firmly so it will not fall against the workpiece.

### MAINTENANCE

**WARNING** To reduce the risk of injury, always unplug the charger and remove the battery pack from the charger or tool before performing any maintenance. Never disassemble the tool, battery pack or charger. Contact a MILWAUKEE® service facility for ALL repairs.

### Maintaining Tool

Keep your tool, battery pack and charger in good repair by adopting a regular maintenance program. Inspect your tool for issues such as undue noise, misalignment or binding of moving parts, breakage of parts, or any other condition that may affect the tool operation. Return the tool, battery pack, and charger to a MILWAUKEE® service facility for repair. After six months to one year, depending on use, return the tool, battery pack and charger to a MILWAUKEE® service facility for inspection.

If the tool does not start or operate at full power with a fully charged battery pack, clean the contacts on the battery pack. If the tool still does not work properly, return the tool, charger and battery pack, to a MILWAUKEE® service facility for repairs.

**WARNING** To reduce the risk of personal injury and damage, never immerse your tool, battery pack or charger in liquid or allow a liquid to flow inside them.

### Cleaning

Clean dust and debris from vents. Keep handles clean, dry and free of oil or grease. Use only mild soap and a damp cloth to clean, since certain cleaning agents and solvents are harmful to plastics and other insulated parts. Some of these include gasoline, turpentine, lacquer thinner, paint thinner, chlorinated cleaning solvents, ammonia and household detergents containing ammonia. Never use flammable or combustible solvents around tools.

### Repairs

For repairs, return the tool, battery pack and charger to the nearest service center.

### ACCESSORIES

**WARNING** Use only recommended accessories. Others may be hazardous.

For a complete listing of accessories, go online to [www.milwaukeeetool.com.au](http://www.milwaukeeetool.com.au) / [www.milwaukeeetool.co.nz](http://www.milwaukeeetool.co.nz) or contact a distributor.



## **WARRANTY - AUSTRALIA and NEW ZEALAND**

Please refer to Australian and New Zealand warranty supplied with tool. This warranty applies only to product sold in Australia and New Zealand.

## **SERVICE - AUSTRALIA and NEW ZEALAND**

MILWAUKEE® prides itself in producing a premium quality product that is Nothing But Heavy Duty™. Your satisfaction with our products is very important to us! If you encounter any problems with the operation of this tool, please contact your authorised MILWAUKEE® dealer.

For a list of MILWAUKEE® dealers, guarantee or service agents please contact MILWAUKEE® Customer Service or visit our website.

(Australia Toll Free Telephone Number 1300 645 928)

(New Zealand Toll Free Telephone Number 0800 645 928)

or visit [milwaukeetool.com.au/milwaukeetool.co.nz](http://milwaukeetool.com.au/milwaukeetool.co.nz).

### **Milwaukee Electric Tool Corporation**

13135 West Lisbon Road, Brookfield, Wisconsin U.S.A. 53005

#### **Milwaukee Tool (Australia)**

21 Kelletts Road, Rowville, VIC 3178  
Melbourne, Australia

#### **Milwaukee Tool (New Zealand)**

274 Church Street, Penrose,  
Auckland, 1061, New Zealand

Designed by Milwaukee Electric Tool Corp.

Professionally Made in China for Milwaukee Tool (Australia) / Milwaukee Tool (New Zealand)

Printed in China